

ENTSORGUNGSKLAPPE
RABAT D'ÉLIMINATION
FLAP DI SMALTIMENTO
TRAMPILLA DE ELIMINACIÓN
DISPOSAL FLAP

USER MANUAL
705.684 V01 10.2021

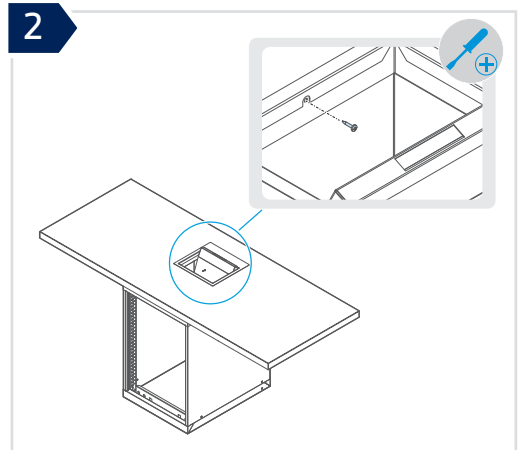

3

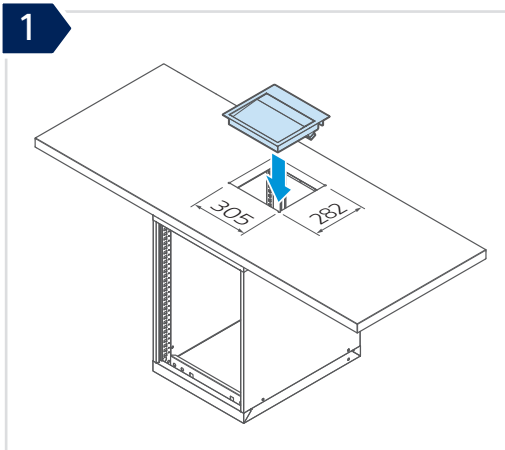
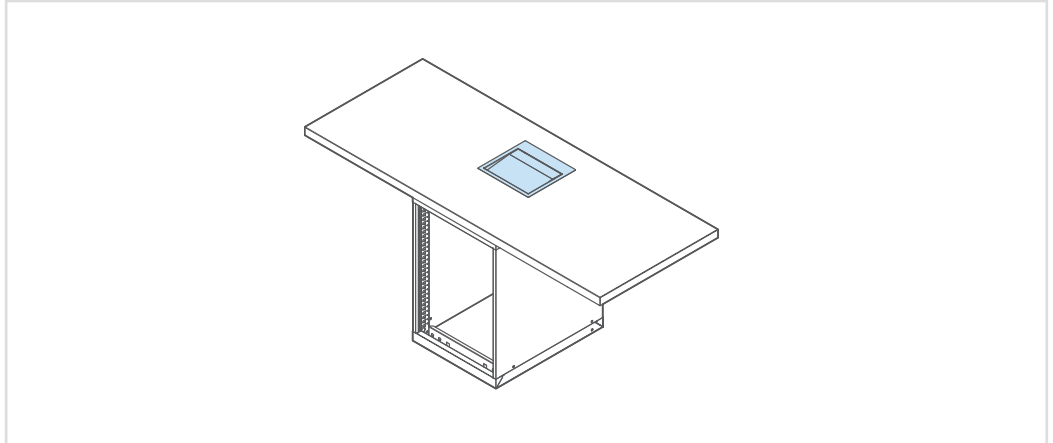
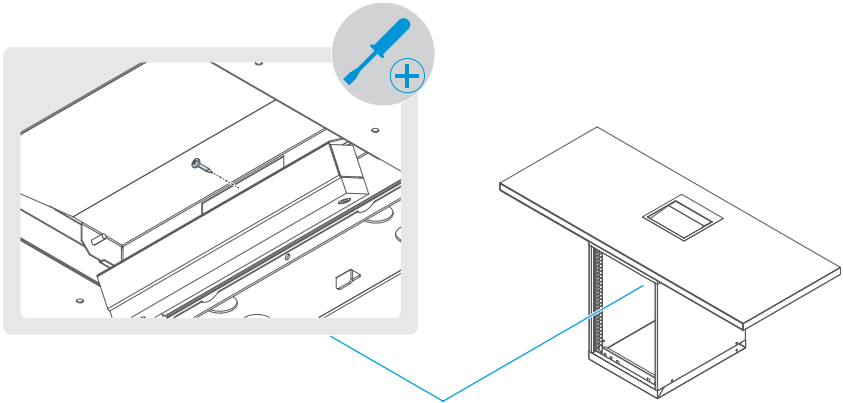

4

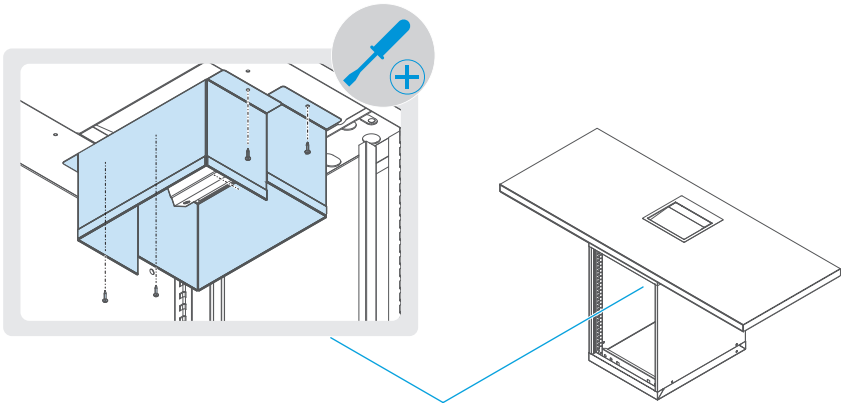

5

